

FLAMINGO POST

E9B153-

base number Finish
 Options

- To build a product code in our configurator select the specify button on the base model # product page
- To build a manual product code on this datasheet choose from the options listed below in blue font and add the suffix to the base model #

GENERAL

Series: Flamingo
 Brand: Platek
 Division: Exterior
 Mounting Type: Post
 Mounting Location: Above Ground
 Subcategory: Bollard - Garden

PHYSICAL

Shape: Abstract
 Diameter (mm): 55
 Diameter (in): 2 ³/₁₆
 Height (mm): 800
 Height (in): 31 ¹/₂
 Extension (mm): 450
 Extension (in): 17 ¹¹/₁₆
 Light Distribution: Direct
 Weight (kg): 1.4
 Weight (lbs): 3
 Screws: No visible screws
 Diffuser: Frosted Methacrylate - 2mm
 Fixture Finish: [BLK / WHI / COR](#)
 Fixture Material: Aluminum
 Upon Request: Finishes - Anthracite, Bronze

ELECTRICAL

Lamp Type: LED
 Input Wattage (W): 9
 Total Output Wattage (W): 7
 Dimming: Non-Dimmable / 0-10V Dimming
 Driver Included: No
 Driver Location: Remote
 Driver Type: Constant Voltage - Universal
 Driver Class: Class 2
 Housing: ENCP5
 Input Voltage (V): 120 - 277
 Constant Voltage (V): 24

LED

Number of LEDs: 1
 Color Temperature (°K): 3000
 Max. Delivered Lumen (lm): 385
 Nominal Lumen (lm): 705
 CRI: >80 CRI
 Lamp Life (hrs): 60000

OPTICAL

Optic°: 76
 Beam Angle: Diffused

RATINGS AND CERTIFICATIONS

Certified By: Certified for North American Standards
 IP rating: IP65
 IK Rating: IK06
 Bug Rating: B0 U0 G0
 Upon Request: Higher Maximum Ambient Temperature

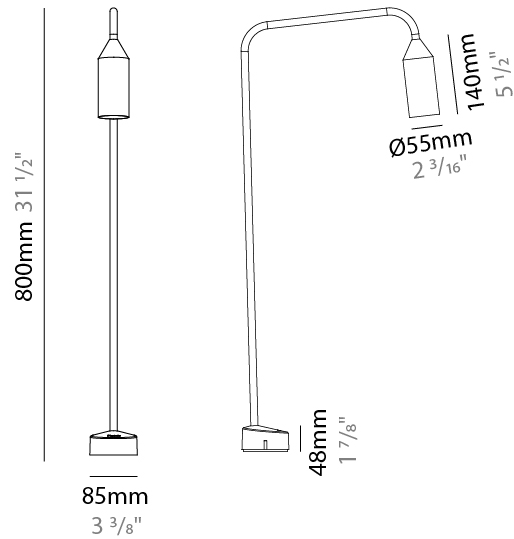

FLAMINGO POST

E9B153-

PROJECT	_____
TYPE	_____
SPECIFIER	_____
QUANTITY	_____
DATE	_____

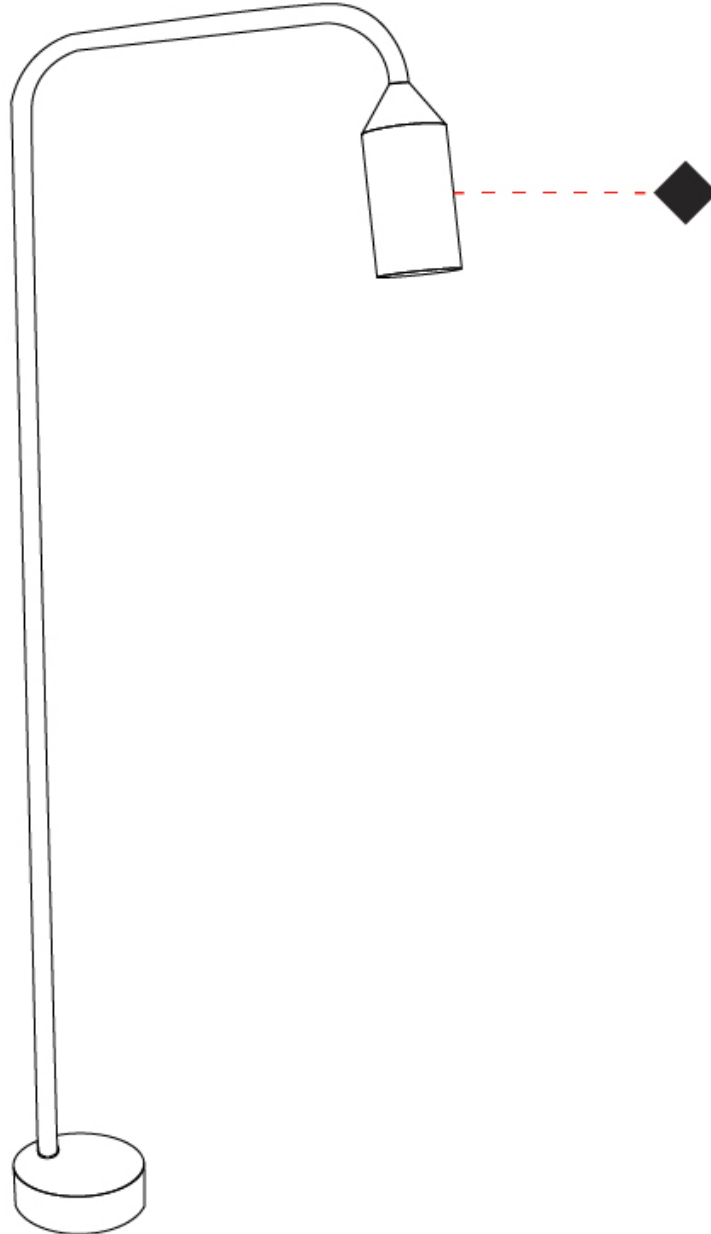

E

PROJECT
TYPE
SPECIFIER
QUANTITY
DATE

FLAMINGO POST

E9B155-

base number Finish
Options

- To build a product code in our configurator select the specify button on the base model # product page
- To build a manual product code on this datasheet choose from the options listed below in blue font and add the suffix to the base model #

GENERAL

Series: Flamingo
 Brand: Platek
 Division: Exterior
 Mounting Type: Post
 Mounting Location: Above Ground
 Subcategory: Bollard

PHYSICAL

Shape: Abstract
 Diameter (mm): 55
 Diameter (in): 2 ³/₁₆
 Height (mm): 1500
 Height (in): 59 ¹/₁₆
 Extension (mm): 450
 Extension (in): 17 ¹¹/₁₆
 Light Distribution: Direct
 Weight (kg): 1.8
 Weight (lbs): 4
 Screws: No visible screws
 Diffuser: Frosted Methacrylate - 2mm
 Fixture Finish: [BLK / WHI / COR](#)
 Fixture Material: Aluminum
 Upon Request: Finishes - Anthracite, Bronze

ELECTRICAL

Lamp Type: LED
 Input Wattage (W): 9
 Total Output Wattage (W): 7
 Dimming: Non-Dimmable / 0-10V Dimming
 Driver Included: No
 Driver Location: Remote
 Driver Type: Constant Voltage - Universal
 Driver Class: Class 2
 Input Voltage (V): 120 - 277
 Constant Voltage (V): 24

LED

Number of LEDs: 1
 Color Temperature (°K): 3000
 Max. Delivered Lumen (lm): 385
 Nominal Lumen (lm): 705
 CRI: >80 CRI
 Lamp Life (hrs): 60000

OPTICAL

Optic°: 76
 Beam Angle: Diffused

RATINGS AND CERTIFICATIONS

Certified By: Certified for North American Standards
 IP rating: IP65
 IK Rating: IK06
 Bug Rating: B0 U0 G0
 Upon Request: Higher Maximum Ambient Temperature

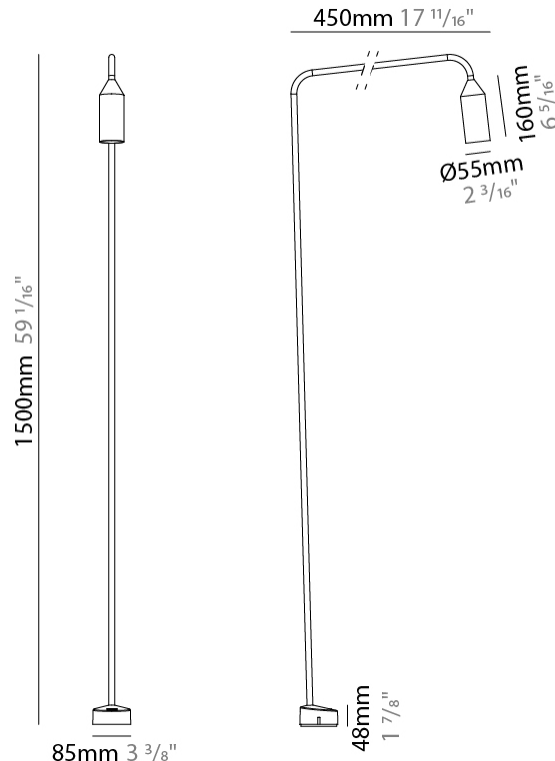

FLAMINGO POST

E9B155-

PROJECT

TYPE

SPECIFIER

QUANTITY

DATE

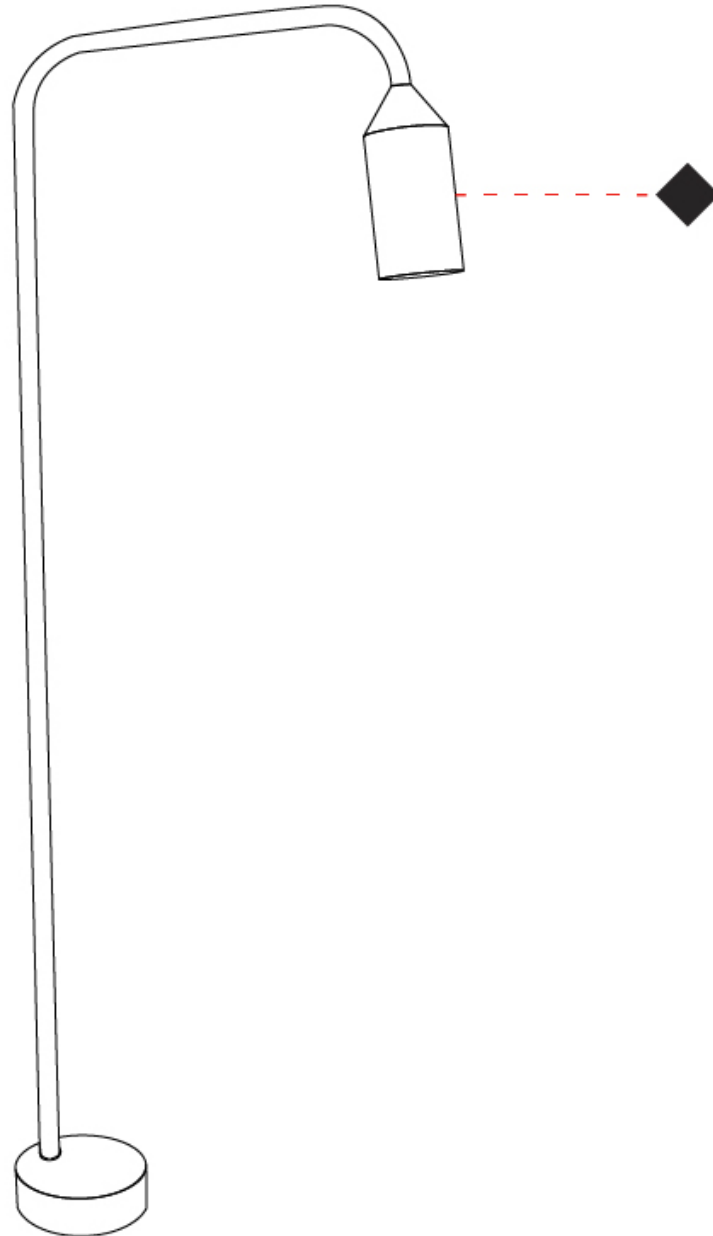

E

FLAMINGO POST

E9B157-

base number Finish
Options

- To build a product code in our configurator select the specify button on the base model # product page
- To build a manual product code on this datasheet choose from the options listed below in blue font and add the suffix to the base model #

GENERAL

Series: Flamingo
Brand: Platek
Division: Exterior
Mounting Type: Post
Mounting Location: Above Ground
Subcategory: Bollard

PHYSICAL

Shape: Abstract
Diameter (mm): 55
Diameter (in): 2 3/16
Height (mm): 1900
Height (in): 74 13/16
Extension (mm): 450
Extension (in): 17 11/16
Light Distribution: Direct
Weight (kg): 2
Weight (lbs): 4.4
Screws: No visible screws
Diffuser: Frosted Methacrylate - 2mm
Fixture Finish: [BLK / WHI / COR](#)
Fixture Material: Aluminum
Upon Request: Finishes - Anthracite, Bronze

ELECTRICAL

Lamp Type: LED
Input Wattage (W): 9
Total Output Wattage (W): 7
Dimming: Non-Dimmable / 0-10V Dimming
Driver Included: No
Driver Location: Remote
Driver Type: Constant Voltage - Universal
Driver Class: Class 2
Input Voltage (V): 120 - 277
Constant Voltage (V): 24

LED

Number of LEDs: 1
Color Temperature (°K): 3000
Max. Delivered Lumen (lm): 385
Nominal Lumen (lm): 705
CRI: >80 CRI
Lamp Life (hrs): 60000

OPTICAL

Optic°: 76
Beam Angle: Diffused

RATINGS AND CERTIFICATIONS

Certified By: Certified for North American Standards
IP rating: IP65
IK Rating: IK06
Bug Rating: B0 U0 G0
Upon Request: Higher Maximum Ambient Temperature

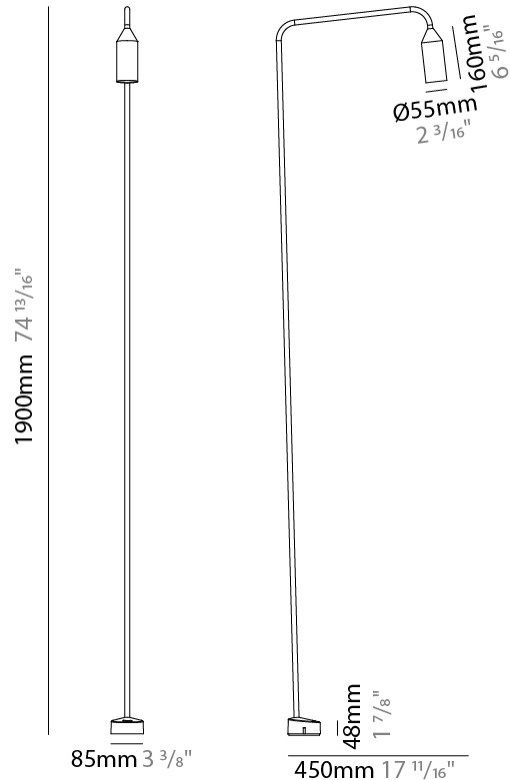

FLAMINGO POST

E9B157-

PROJECT

TYPE

SPECIFIER

QUANTITY

DATE

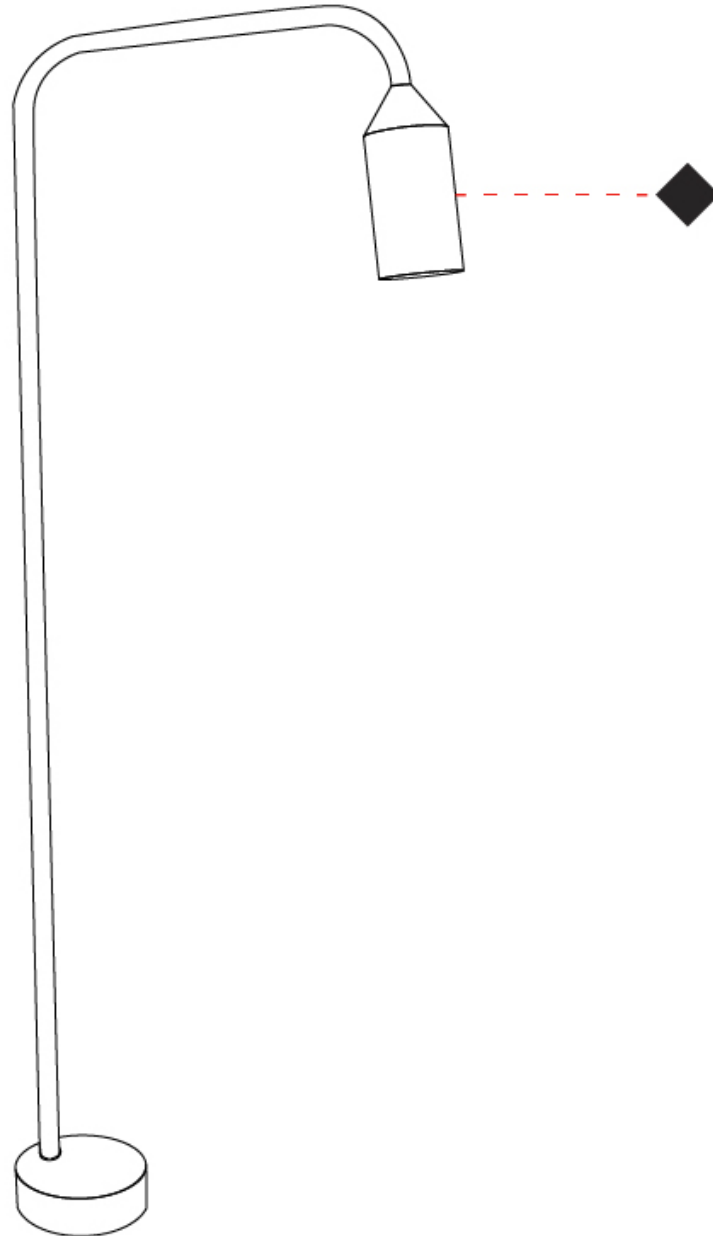

E

FLAMINGO COLOR FINISH CHART

PROJECT _____

TYPE _____

SPECIFIER _____

QUANTITY _____

DATE _____

Fixture Finish

Black - BLK



White - WHI

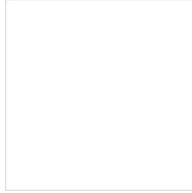

Corten - COR



Digital: Not all screens are calibrated the same, and therefore, colors will appear differently between screens.

Physical: When texture is involved, there will be variations in color, character and tone within a product series and between product families.



LEGEND

	floor-mounted		pivotal		special LED (upon request) RGB, RGBW, tunable, gold+, meat+, art+, fashion+
	wall and ceiling: recessed and surface mounted		rotating		warm dim / natural dimming LED
	ceiling-mounted and wall-mounted		illuminate tilted		rechargeable battery powered
	wall-mounted		color of suspension cable		fixture with natural vivid LED (upon request)
	omni-directional light distribution		length of suspension cable		color rendering index
	direct light distribution		reflector degree selection		color temperature
	direct/indirect light distribution		super spot		lumen (luminous flux)
	indirect light distribution		lens		efficacy (lumens per watt)
	asymmetric light distribution		lens pack		Unified Glare Rating (UGR) range from 5-40
	aura light distribution		shine ring		marine grade (AISI 316 stainless steel)
	round wall or ceiling cut-out		integrated shine ring with diffuser		walk on
	square wall or ceiling cut-out		free individual colors 01-29		drive on
	the supplied jig specifies the cutout dimensions		individual colors: 00 (free of charge), 01-25 (extra charge)		Dark Sky Compliance
	minimum distance (meters) lamp - object		luminaire part to be colored (F1)		Americans with Disabilities Act (less than 4" off the wall located between 27"-84" from floor)
	recessed depth		luminaire part to be colored (F2)		lamp protected against explosion
	ceiling thickness in mm		luminaire part to be colored (F3)		blown glass using traditional methods by master glass blower
	ceiling thickness selection		luminaire part to be colored (F4)		acoustic material
	dimnable DP (phase), DV (0-10V), DD (dali), DS (step-dim)		luminaire part to be colored (F5)		protection class I, protection insulation
	included or excluded LED driver/transformer/control gear		color of 3-circuit adaptor		protection class II, protection insulation
	separately switchable		indirect diffuser		ETL Certified to UL and CSA Standards
	sensor		direct diffuser		UL Certified to UL and CSA Standards
	remote control		ball-proof (upon request)		CSA Certified to UL and CSA Standards
	available upon request		accessory		Certified for North American Standards

IP RATING

	protected against ingress of solid bodies greater than 12.5mm (finger)
	protected against ingress of solid bodies greater than 2.5mm protected against sprays of water up to 60 degrees from the vertical (rain)
	protected against ingress of solid bodies greater than 1mm (wire) no protection against the ingress of moisture
	protected against ingress of solid bodies greater than 1mm (wire) protected against sprays of water up to 60 degrees from the vertical (rain)
	protected against ingress of solid bodies greater than 1mm (wire) protected against water splashed from all directions
	protected against limited ingress of dust (wet rooms/covered outdoor areas) protected against water splashed from all directions
	protected against ingress of dust protected against jets of water
	protected against ingress of dust protected against powerful jets of water or heavy seas
	protected against ingress of dust protected against immersion of water between 15cm - 1m for 30 minutes
	protected against ingress of dust protected against immersion of water under pressure for long periods

IK RATING

	protected against 0.14 joules impact (equivalent to 0.25kg mass dropped from 56mm above the surface)
	protected against 0.2 joules impact (equivalent to 0.25kg mass dropped from 80mm above the surface)
	protected against 0.35 joules impact (equivalent to 0.25kg mass dropped from 140mm above the surface)
	protected against 0.5 joules impact (equivalent to 0.25kg mass dropped from 200mm above the surface)
	protected against 0.7 joules impact (equivalent to 0.25kg mass dropped from 280mm above the surface)
	protected against 1 joules impact (equivalent to 0.25kg mass dropped from 400mm above the surface)
	protected against 2 joules impact (equivalent to 0.5kg mass dropped from 400mm above the surface)
	protected against 5 joules impact (equivalent to 1.7kg mass dropped from 300mm above the surface)
	protected against 10 joules impact (equivalent to 5.0kg mass dropped from 200mm above the surface)
	protected against 20 joules impact (equivalent to 5.0kg mass dropped from 400mm above the surface)